

## 398.090.056.20 BADEROSMRENNE WATERLINE 900

- Gulv: betong og flis
- Ramme: rektangulær
- Utløp: Ø50 mm, vertikal
- Rustfritt stål: AISI304/EN1.4301

### Produktkoder

EAN: 5705499138399  
VVS-nummer: 155063009  
RSK-nummer: 7121706  
NRF-nummer: 3394728

### Spesifikasjon

Gulv: Betong / flis  
Materiale: AISI 304  
Materiale (EN): EN 1.4301  
Plassering av utløp: Ende  
Ramme: Rektangulær  
Størrelse: 50x900  
Sump: Nei  
Type: Renner  
Type membran: Fastmembran  
Utløpdiameter (mm): 50  
Utløpsretning: Vertikal  
Vekt (kg): 4,24

### Godkjenninger



NO - TG 2484



SE - RI.SE 0084-07 2021



SE - RI.SE SC0399-11 2020 Type 398 WaterLine

PL - Hygienic Certificate - All products

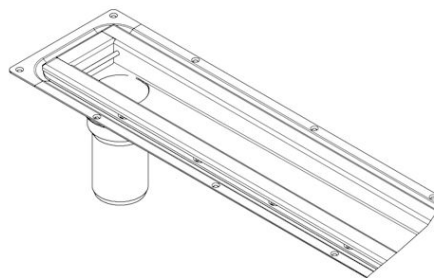
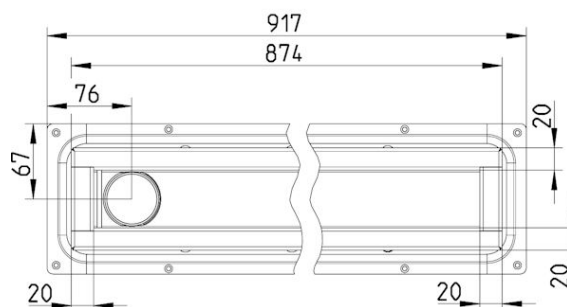
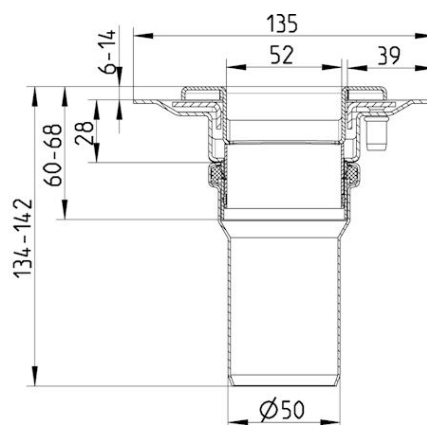

# BLÜCHER®