

Vieser One

Vieser Oy

tel. +358 20 746 4400

www.vieser.no

NO Åpning av anbringen

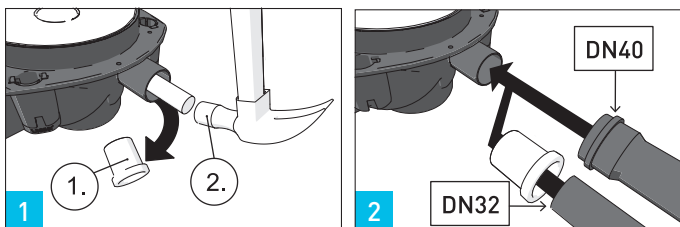

NO Betongbjelkelag

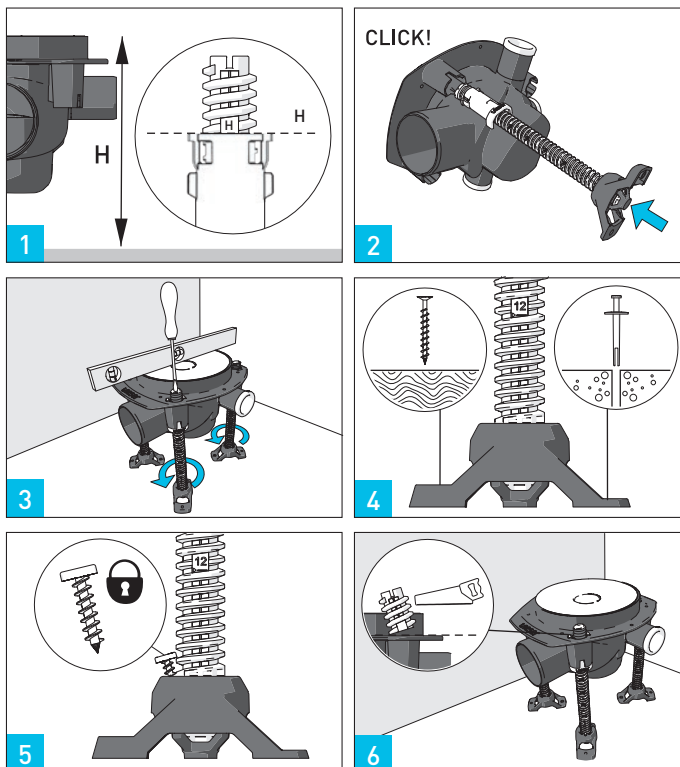

NO Vieser gulvsluksystem monteringsanvisninger

Vieser gulvsluk og forhøyningsringer er typegodkjente. Godkjenningens gyldighet forutsetter at alle produkter som brukes tilhører samme Vieser produktserie.

NO Trebjelkelag

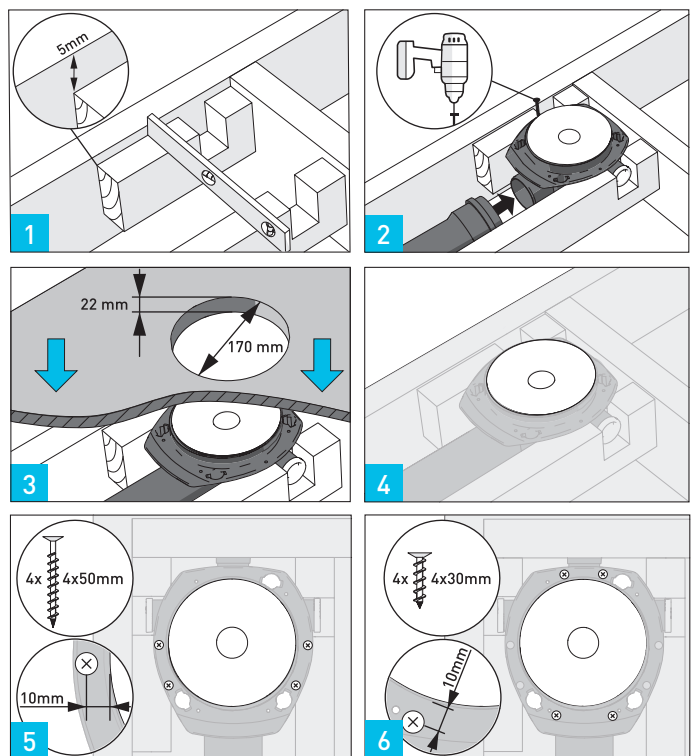

⚠ Se til at skruene ikke treffer rørene.

NO Skjær ut et hull på 170 mm i treplaten. Skru på plass sluket med 6 4x20 mm skruer. Monter understøttelse på minst ensiden in henhold til BVN 42.110

Skal det støpes betong på tregulvet, benyttes forhøyningsring 51185 (NRF:3410823)

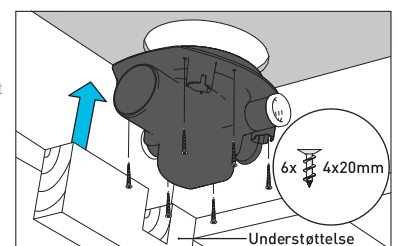

(NO) Montering av forhøyingsringen

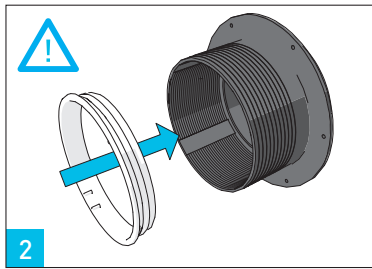
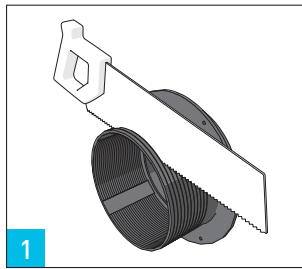

- (NO)** 1. Kutt forhøyingsringen rett.
2. Trykk fast den hvite støttingen ned til bunnen.

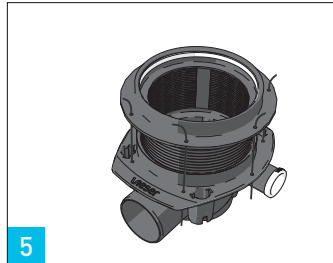
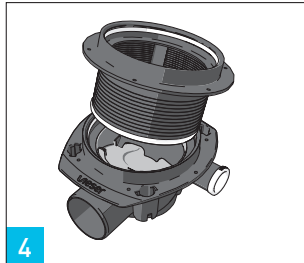
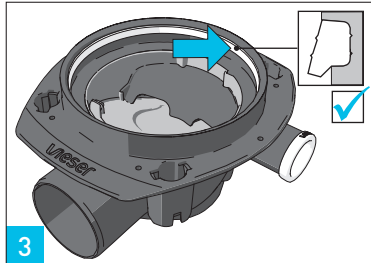

(NO) Membran / smøremembran / foliebasert tettsjikt

