

Slate

4 shower system

Article no.: 579217400
Finish: Chrome/Black
Series: Slate

EAN no.: 5708516825586



Standard features:

- Rub-Clean
- Scalding protection (38°C)
- Head Shower max. 17 l/m / Hand Shower max. 9 l/m
- Adjustable Height
- 1750 mm metal hose
- Integrated diverter
- Non Ceramic Headpart
- Standard 150mm centres
- Eco-Click water saving feature
- With 3/4" wall plates & eccentric unions

Product features

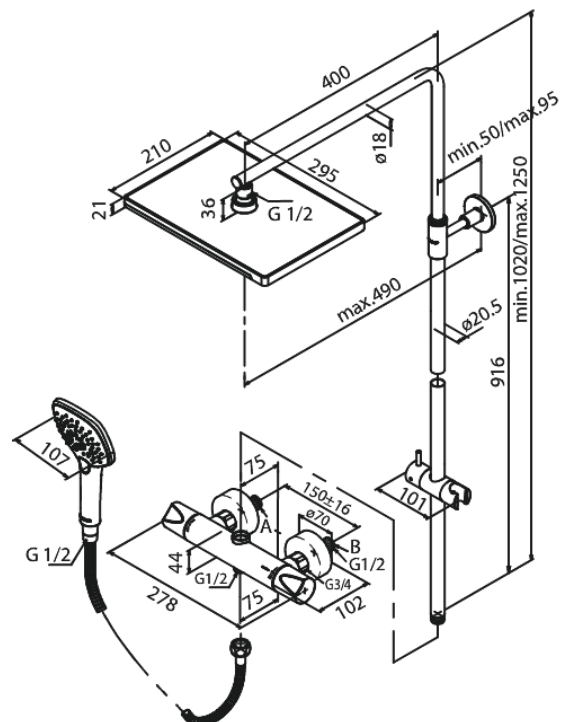

FM Mattsson Denmark ApS
Hvidkærvej 48, 5250 Odense SV, DK-56416218

+45 88 33 00 34 damixa-international@fmmattsongroup.com

Mere information på damixa.com

damixa