

650.200.107 MONTERINGSSETT SQUARE HYGIENICPRO

- Med skruelås og klemring
- Gulv: betong og flis
- Ramme: 197 x 197 mm
- Rustfritt stål: AISI304/EN1.4301

Produktkoder

EAN: 5705499129298
RSK-nummer: 7122118
NRF-nummer: 3394502
LVI-nummer: 3304146

Spesifikasjon

Antall skruer: 2
Gulv: Betong / flis
Lasteklasse EN1253(kg): L15 (3.000)
Materiale: AISI 304
Materiale (EN): EN 1.4301
Ramme: Firkant
Størrelse: 200x200
Type: Monteringssett
Utløpdiameter (mm): 110
Vekt (kg): 1,43

Godkjenninger

PL - Hygienic Certificate - All products

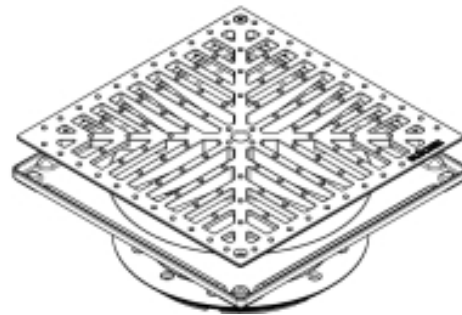
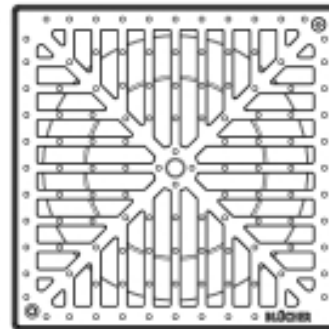
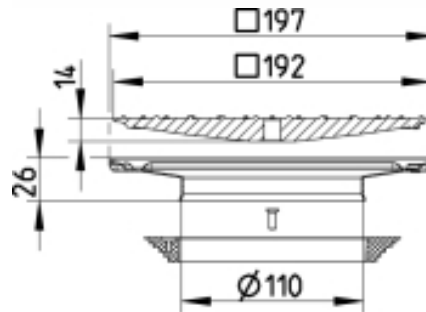

BLÜCHER®